

# Arida<sup>®</sup>

## CORPORATION



# 2025 PRODUCT CATALOG

THE **PREFERRED CHOICE** OF BUILDERS, CONTRACTORS & ELECTRICIANS

# WHY **Aida**

## **Aida** QUALITY

The Aida quality control process is built upon a foundation of rigorous testing and continuous improvement. From raw material selection to final product assembly, we employ a comprehensive approach to ensure that every single wiring device meets the highest standards of safety and performance. All Aida products are UL-certified with additional ISO 9000 certification on the manufacturing process, and are crafted from decades of experienced OEM engineering, demonstrating to our commitment to top-tier quality.

## **Aida** SERVICE

Aida takes pride in executing on our shipping service guarantee, with 99% of orders departing our well-stocked U.S. warehouse within 24 hours of placing your order, ensuring you can meet customer demands promptly. Exclusively serving electrical distributors, Aida commits to never selling directly to your customers, thus preserving your market. Beyond the products, we offer a partnership where you are treated like family, with personalized service that acknowledges and prioritizes your needs.

## **Aida** PRICE

At Aida, customers receive top-notch service, leading brand quality, and to complete the picture, prices that ensure that business is never lost. We are the only manufacturer of electrical wiring devices that boasts the lowest defect rate in the industry at just 0.0003%, significantly outperforming the top four leading brands. We maintain lean operational costs and utilize strategic partnerships in our research, development, and manufacturing processes allowing us to offer industry-low prices.



# ABOUT US

At Aida Corporation (Aida), headquartered in Jacksonville, FL., the commitment to strong partnerships, ambitious goals, and delivering top-tier products remains unwavering. The shared success between Aida and partners is built upon three core values—Aida Quality, Aida Service, and Aida Pricing—ensuring high-quality products, on-time delivery, and the most competitive pricing in the electrical distribution market.

Founded in 2017, Aida has quickly established itself as a trusted name in the electrical wiring device industry. Every product at Aida rides on the 30+ years of experience with its direct relationship with strategic partners that supply the US and global markets. Aida maintains competitive prices through lean operations and strategic partnerships, allowing clients to enhance their margins without sacrificing quality.

Aida remains 100% dedicated to the Electrical Distribution Channel—no big box, no Internet sales, no distractions. The company has a sole focus on empowering partners and strengthening the electrical distribution market. As a respected Tier II manufacturer of wiring devices, Aida provides electrical distributors with the tools they need to succeed. Boasting a highest-in-the-industry, reliability rate of 99.99%, accompanied by industry-low pricing, Aida is continually setting new standards in the market.

# CONTENTS

<b>RECEPTACLES</b>	<b>4</b>
Residential Grade	4
Commercial Grade	6
Ground Fault Circuit Interrupter	8
GFCI Receptacles with Night Light	10
Dual Type USB Charging	11
GFCI + USB Combinations	12
High-Rate USB Charging	14
USB Power Adapters	16
Portable GFCI Devices	17
<b>POWER &amp; CHARGING DEVICES</b>	<b>18</b>
Power Devices	18
Locking Devices	20
Twist-lock Inlet Plugs & Receptacles	21
Charging Outlets	22
<b>SWITCHES</b>	<b>24</b>
Decorative Switches	24
Toggle Switches	26
Combo Switches	27
<b>LIGHTING CONTROLS AND DIMMERS</b>	<b>28</b>
<b>WALL PLATES</b>	<b>32</b>
Thermoplastic (Unbreakable) Wall Plates	33
Thermoset Wall Plates	34
Screwless Wall Plates	34
Metal Wall Plates	35
Stainless Steel Wall Plates	36
<b>WEATHERPROOF COVERS</b>	<b>37</b>
<b>WIRE CONNECTORS</b>	<b>39</b>
<b>LAMP HOLDERS, ADAPTERS &amp; CONNECTORS</b>	<b>40</b>
<b>NEW AIDA PRODUCTS</b>	<b>42</b>



# RESIDENTIAL GRADE RECEPTACLES

The full line of Aida Residential and Commercial grade receptacles includes devices in a variety of standard configurations and colors.

- High impact-resistant thermoplastic construction
- Tamper-resistant shutter system to prevent improper insertion of foreign objects
- Package contains outlet with mounting screws attached
- Side-Wire and push wire terminations
- Accepts #14 wire for back push, or #12 wires for side installation
- For replacement of any household outlet
- Complies with UL 498, meets NEMA WD-6 & 2008 NEC Code requirements

10 PACK RESIDENTIAL DUPLEX RECEPTACLES		NEMA	RATING	COLOR	PART #	
	15 Amp Residential Duplex Receptacle	Standard, Side- & Push-Wire	5-15R 	15A, 125V	White	030541 (10 Pack of 030101)
		Tamper-Resistant, Side- & Push-Wire			White	030561 (10 Pack of 030121)
	20 Amp Residential Duplex Receptacle	Standard, Side-Wire	5-20R 	20A, 125V	White	030551 (10 Pack of 030111)
		Tamper-Resistant, Side- & Back-Wire			White	030571 (10 Pack of 030131)
	15 Amp Residential Decorative Receptacle	Standard, Side- & Push-Wire	5-15R 	15A, 125V	White	030581 (10 Pack of 030281)
		Tamper-Resistant, Side- & Push-Wire			White	030601 (10 Pack of 030301)
	20 Amp Residential Decorative Receptacle	Standard, Side-Wire	5-20R 	20A, 125V	White	030591 (10 Pack of 030291)
		Tamper-Resistant, Side- & Back-Wire			White	030611 (10 Pack of 030311)
	15 Amp Residential Duplex Receptacle	Tamper-Resistant & Weather-Resistant, Side- & Back-Wire	5-15R 	15A, 125V	White	030651 (10 Pack of 030151)

10 PACK ONLY  
Part# 030611



Part # 030364









10 PACK ONLY  
Part# 030561



All receptacles are offered in the following colors:

- White
- Ivory
- Light Almond
- Black

2-POLE, 3-WIRE, SELF-GROUNDING

CATEGORY	RESIDENTIAL DUPLEX RECEPTACLE	NEMA	RATING	COLOR	PART #
15 Amp Residential Duplex Receptacle	Standard, Side- & Push-Wire	5-15R 	15A, 125V	White 10 Pack Ivory Light Almond Black	030541 (10pk only) 030102 030104 030106
	Tamper-Resistant, Side- & Push-Wire			White 10 Pack Ivory Light Almond Black	030561 (10pk only) 030122 030124 030126
	Tamper-Resistant, Side- & Back-Wire			White Ivory Light Almond Black	030141 030142 030144 030146
	Tamper-Resistant & Weather-Resistant, Side- & Back-Wire			White 10 Pack Ivory Light Almond Black	030651 (10pk only) 030152 030154 030156
20 Amp Residential Duplex Receptacle	Standard, Side-Wire	5-20R 	20A, 125V	White 10 Pack Ivory Light Almond Black	030551 (10pk only) 030112 030114 030116
	Tamper-Resistant, Side- & Back-Wire			White 10 Pack White Ivory Light Almond Black	030541 (10pk only) 030131 030133 030132 030137
	Tamper-Resistant & Weather-Resistant, Side- & Back-Wire			White Ivory Light Almond Black	030134 030135 030136 030138
CATEGORY	RESIDENTIAL DECORATIVE DUPLEX RECEPTACLE	NEMA	RATING	COLOR	PART #
15 Amp Residential Decorative Duplex Receptacle	Standard, Side- & Push-Wire	5-15R 	15A, 125V	White 10 Pack Ivory Light Almond Black	030581 (10pk only) 030282 030284 030286
	Tamper-Resistant, Side- & Push-Wire			White 10 Pack Ivory Light Almond Black	030601 (10pk only) 030302 030304 030306
	Tamper-Resistant, Side- & Back-Wire			White Ivory Light Almond Black	030331 030332 030334 030336
20 Amp Residential Decorative Duplex Receptacle	Standard, Side-Wire	5-20R 	20A, 125V	White 10 Pack White Ivory Light Almond Black	030591 (10pk only) 030291 030292 030294 030296
	Tamper-Resistant, Side- & Back-Wire			White 10 Pack Ivory Light Almond Black	030611 (10pk only) 030312 030314 030316
CATEGORY	RESIDENTIAL SINGLE RECEPTACLE	NEMA	RATING	COLOR	PART #
15 Amp Residential Single Receptacle	Standard, Side-&, Back-Wire	5-15R 	15A, 125V	White Ivory Light Almond Black	030351 030352 030354 030356
	Tamper-Resistant, Side- & Back-Wire			White Ivory Light Almond Black	030371 030372 030374 030376
20 Amp Residential Single Receptacle	Standard, Side- & Back-Wire	5-20R 	20A, 125V	White Ivory Light Almond Black	030361 030362 030364 030366
	Tamper-Resistant, Side- & Back-Wire			White Ivory Light Almond Black	030381 030382 030384 030386

# COMMERCIAL GRADE RECEPTACLES



Aida offers a large selection of 15 Amp and 20 Amp commercial grade receptacles available in a wide variety of colors, wiring options and other features. Commercial receptacles made by Aida are manufactured to withstand the demands of commercial and institutional applications. These commercial receptacles provide long-lasting service life and are a cost-saving alternative to the industrial devices.



Part # 030401





Part # 030531

COMMERCIAL GRADE DUPLEX RECEPTACLE 2-POLE, 3-WIRE SELF-GROUNDING		NEMA	RATING	COLOR	PART #
15 Amp Commercial Grade Duplex Receptacle	Standard, Side- & Back-Wire	5-15R 	15A, 125V	White	030401
	Tamper-Resistant, Side-Wire & Back-Wire			Ivory	030402
				Light Almond	030404
				Black	030406
				White	030411
				Ivory	030412
				Light Almond	030414
				Black	030416
20 Amp Commercial Grade Duplex Receptacle	Standard, Side-Wire & Back-Wire	5-20R 	20A, 125V	White	030441
	Tamper-Resistant, Side-Wire & Back-Wire			Ivory	030442
				Light Almond	030444
				Black	030446
				White	030451
				Ivory	030452
				Light Almond	030454
				Black	030456
				White 10 Pack	030621 - 10pack
COMMERCIAL GRADE DECORATIVE RECEPTACLE, 2-POLE, 3-WIRE SELF-GROUNDING		NEMA	RATING	COLOR	PART #
15 Amp Commercial Grade Decorative Receptacle	Standard, Side-Wire & Back-Wire	5-15R 	15A, 125V	White	030481
	Tamper-Resistant, Side-Wire & Back-Wire			Ivory	030482
				Light Almond	030484
				Black	030486
				White	030491
				Ivory	030492
				Light Almond	030494
				Black	030496
20 Amp Commercial Grade Decorative Receptacle	Standard, Side-Wire & Back-Wire	5-20R 	20A, 125V	White	030521
	Tamper-Resistant, Side-Wire & Back-Wire			Ivory	030522
				Light Almond	030524
				Black	030526
				White	030531
				Ivory	030532
				Light Almond	030534
				Black	030536
				White 10 Pack	030631 - 10pack



# 10-PACK RECEPTACLE SAVINGS

Streamline your projects with Commercial Grade Receptacles from Aida, now available in convenient 10-packs. This packaging solution minimizes packaging waste, enhances installer productivity, and reinforces the Aida commitment to industry-leading low pricing. Our 20 Amp Commercial Grade Receptacles, now offered in 10-packs as both standard duplex and decorative designs, are engineered to help you power through projects with ease.

10-PACK COMMERCIAL GRADE RECEPTACLES		NEMA	RATING	COLOR	PART #
20 Amp Commercial Grade Duplex Receptacle	Tamper-Resistant, Side- & Back-Wire	5-20R 	20A, 125V	White	030621 (10-pack of 030451)
20 Amp Commercial Grade Decorative Receptacle	Tamper-Resistant, Side- & Back-Wire	5-20R 	20A, 125V	White	030631 (10-pack of 030531)

- High Impact Resistant Thermoplastic Construction
- Tamper-Resistant Shutter System Prevents Improper Insertion of Foreign Objects
- Instructions & Mounting Screws Included
- Side-Wire and Push-Wire Terminations
- Accepts #14 Gauge for Back-Wire, Push-Wire, or #12 Gauge for Side-Wire Installation
- Complies with UL 498, Meets NEMA WD-6 & 2008 NEC Code Requirements

# GROUND FAULT CIRCUIT INTERRUPTER

Aida Ground Fault Circuit Interrupter (GFCI) Receptacles incorporate the latest safety features for ground fault protection by automatically conducting a periodic internal self-test to confirm that the GFCI is able to respond to a ground fault. The standards for these safety products are set forth by Underwriters Laboratory (UL) in UL 943 (GFCI) and UL 498 (Receptacles). Aida GFCI receptacles are available in Tamper-Resistant (TR) and Weather-Resistant (WR) versions.

### Standard (Self-Test)

- UL and cUL listed, fully compliant with all latest UL 943 Class A GFCI
- When downstream receptacles are wired from load side, a 15A/20A feed through rating offers full protection
- Trip threshold (5mA+/-1mA) and response time (0.025 sec.) meet Class A requirements
- Tapered Back-Wire openings handle multiple wire sizes and types for applications up to stranded wire
- Test & Reset buttons are color-matched and recessed to provide uniform appearance
- Durable Thermoplastic construction is chemical and impact-resistant
- Status Indicator Light provides power and protection status as well as indication of line/load reversal
- Matching thermoplastic wall plate with screws and wire nuts included
- Limited 2-year warranty

### Tamper-Resistant

- TR symbol (where stated) assures compliance with the National Electrical Code (NEC)
- Shutter mechanism inside the receptacle blocks access to the contacts unless a two-prong or three-prong plug is inserted







### Testing Compliance

- Meets all UL 943 and UL 498 requirements and applicable CSA requirements





### Material Characteristics

- Meets flammability requirements per UL 94, V2 rated
- Temperature Rating: -35°C/-31F° to 66°C/150° F

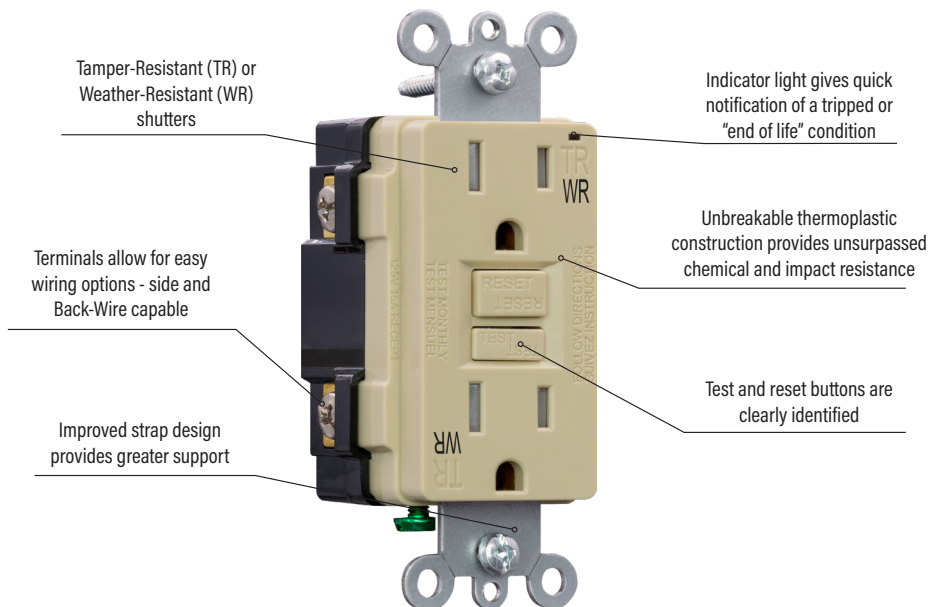
All GFCI receptacles are offered in the following colors:



	White
	Ivory
	Light Almond
	Black
	Brown
	Gray



SELF-TEST GFCI DUPLEX RECEPTACLE WITH LED LIGHT		NEMA	RATING	COLOR	PART #
15 Amp	Standard	5-15R 	Receptacle: 15A, 120V Feed Through: 20A, 120V	White Ivory Light Almond Black	010011 010012 010014 010016
	Tamper-Resistant			White Ivory Light Almond Black Brown Gray	010031 010032 010034 010036 010037 010038
	Tamper- & Weather-Resistant			White Ivory Light Almond Black Brown Gray	010041 010042 010044 010046 010047 010048
20 Amp	Standard	5-20R 	Receptacle: 20A, 120V Feed Through: 20A, 120V	White Ivory Light Almond Black	010051 010052 010054 010056
	Tamper-Resistant			White Ivory Light Almond Black Brown Gray	010071 010072 010074 010076 010077 010078
	Tamper- & Weather-Resistant			White Ivory Light Almond Black Brown Gray	010081 010082 010084 010086 010087 010088
BLANK FACE GFCI DUPLEX RECEPTACLE WITH LED LIGHT		NEMA	RATING	COLOR	PART #
Blank Face	Standard	N/A	Feed Through: 20A, 120V	White Ivory Light Almond Black	010091 010092 010094 010096
	Weather-Resistant			White Ivory Light Almond Black	010101 010102 010104 010106
SELF-TEST + SELF-GROUNDING GFCI DUPLEX RECEPTACLE WITH LED LIGHT		NEMA	RATING	COLOR	PART #
15Amp	Tamper-Resistant Tamper-Resistant Tamper- & Weather-Resistant	5-15R 	15A, 120V	White Ivory White	010125 010129 010135
20Amp	Tamper-Resistant Tamper-Resistant Tamper- & Weather-Resistant	5-20R 	20A, 120V	White Ivory White	010155 010159 010165

# GFCI RECEPTACLES WITH NIGHT LIGHT

Aida Night Light receptacles are equipped with a photosensitive sensor that senses low light levels, turning on and off automatically. Screwless and color matching wall plate included.

GFCI RECEPTACLE WITH NIGHT LIGHT		NEMA	RATING	COLOR	PART #
15 Amp GFCI Duplex Receptacle	Standard	5-15R 	Receptacle: 15A, 120V Feed Through: 20A, 120V	White	010241
	Tamper-Resistant			Ivory	010242
				Light Almond	010244
Tamper-Resistant & Weather-Resistant				Black	010246
				White	010251
				Ivory	010252
20 Amp GFCI Duplex Receptacle	Standard	5-20R 	Receptacle: 20A, 120V Feed Through: 20A, 120V	Light Almond	010254
	Tamper-Resistant			Black	010256
				White	010261
Tamper-Resistant & Weather-Resistant				Ivory	010262
				Light Almond	010264
				Black	010266
Standard				White	010271
				Ivory	010272
				Light Almond	010274
Tamper-Resistant				Black	010276
				White	010281
				Ivory	010282
Tamper-Resistant & Weather-Resistant				Light Almond	010284
				Black	010286
				White	010291
				Ivory	010292
				Light Almond	010294
				Black	010296

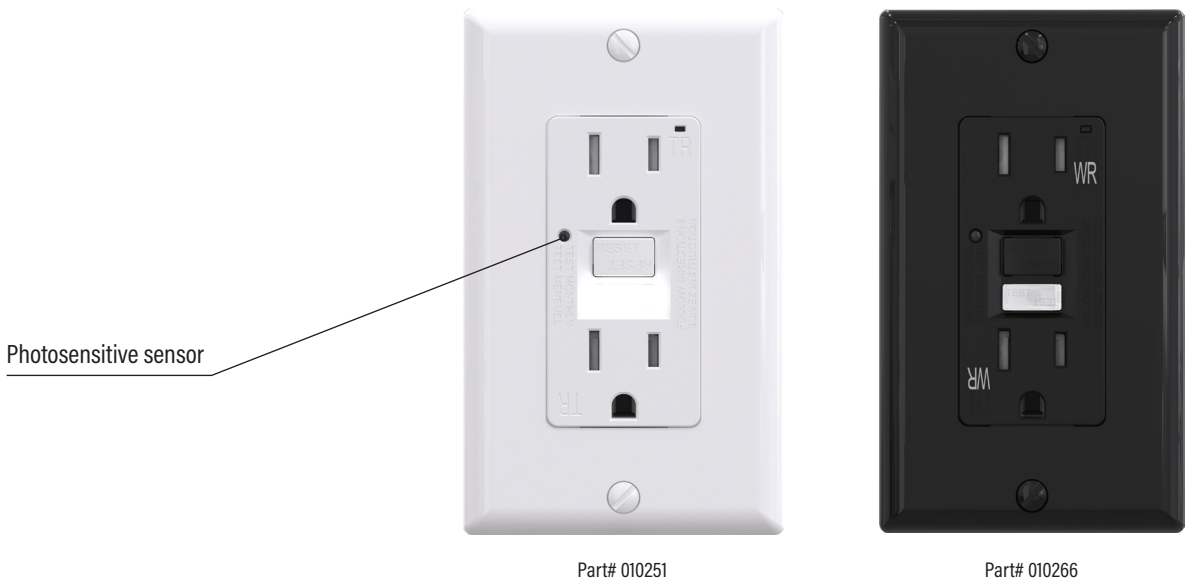



# DUAL TYPE USB CHARGING PORTS

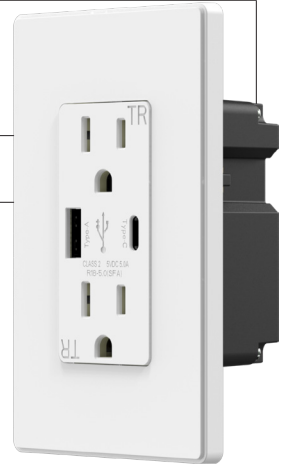

Part # 031261

Our USB Charging Receptacles offer powerful charging capabilities to get your electronic devices up and running fast.

USB CHARGING PORTS TAMPER-RESISTANT RECEPTACLES		NEMA	COLOR	PART #
3.6 Amp	Dual Type A USB Charging Ports 15 Amp Duplex Tamper-Resistant	5-15R 	White Ivory Light Almond Black	031001 031002 031004 031006
	Dual Type A USB Charging Ports 20 Amp Duplex Tamper-Resistant	5-20R 	White Ivory Light Almond Black	031011 031012 031014 031016
	Dual Type A USB Charging Ports 15 Amp Single Tamper-Resistant	5-15R 	White Ivory Light Almond Black	031021 031022 031024 031026
3.0 Amp	Dual Type A USB Charging Ports 15 Amp Duplex Tamper-Resistant	5-15R 	White Ivory Light Almond Black	031031 031032 031034 031036
	Dual Type A USB Charging Ports 20 Amp Duplex Tamper-Resistant	5-20R 	White Ivory Light Almond Black	031041 031042 031044 031046
	Dual Type A USB Charging Ports 15 Amp Single Tamper-Resistant	5-15R 	White Ivory Light Almond Black	031051 031052 031054 031056
4.0 Amp	Quad Type A USB Charging Ports	N/A	White Ivory Light Almond Black	031061 031062 031064 031066
	Dual Type A USB Charging Ports 15 Amp Duplex Tamper-Resistant	5-15R 	White Ivory Light Almond Black	031361 031362 031364 031366
	Dual Type A USB Charging Ports 20 Amp Duplex Tamper-Resistant	5-20R 	White Ivory Light Almond Black	031371 031372 031374 031376
4.2 Amp	Dual Type A USB Charging Ports 15 Amp Duplex Tamper-Resistant	5-15R 	White Ivory Light Almond Black	031341 031342 031344 031346
	Dual Type A USB Charging Ports 20 Amp Duplex Tamper-Resistant	5-20R 	White Ivory Light Almond Black	031351 031352 031354 031356
	Dual Type A+C USB Charging Ports 15 Amp Duplex Tamper-Resistant	5-15R 	White 10 Pack White Ivory Light Almond Black	031431 - 10 Pack 031261 031262 031264 031266
	Dual Type A+C USB Charging Ports 20 Amp Duplex Tamper-Resistant	5-20R 	White 10 Pack White Ivory Light Almond Black	031441 - 10 Pack 031271 031272 031274 031276



# GFCI + USB COMBINATIONS



- **Junction Box:** Standard/Regular depth so there's no need to change or install J-Box.
- **Multi-Function Design:** Combines GFCI protection, USB charging, and optional sensor-controlled night lights, ideal for compact spaces.
- **Rigorous Testing & Safety:** Exceeds UL standards with over 6000 endurance tests; includes reversed wiring prevention and a reset/disable system for enhanced safety.
- **Advanced Self-Testing:** Patented self-test mechanism performs checks every 5 seconds for continuous protection.
- **USB Charging & Smart Features:** Dual USB ports (Type A/C and Type C/C) with smart charging chip for optimized, safe charging (up to 24W total output).
- **Durability & Compatibility:** Constructed from high-impact, flame-retardant thermoplastics; fits all standard junction boxes and decorative devices, with tamper-resistant shutters and optional self-grounding.



Part# 010331

SELF-GROUNDING, 5V, 24W, IN-WALL USB CHARGING GFCI RECEPTACLES INCLUDES MID-SIZE SCREW-LESS WALL PLATE		
CONFIGURATION	COLOR	PART #
Type A+C 15A, 120V	White	010301
	Ivory	010302
	Light Almond	010304
	Black	010306
Type A+C 15A, 120V Tamper-Resistant	White	010311
	Ivory	010312
	Light Almond	010314
	Black	010316
Type A+C 15A, 120V Tamper-Resistant w/Night Light	White	010321
	Ivory	010322
	Light Almond	010324
	Black	010326
Dual Type C 15A, 120V Tamper-Resistant	White	010331
	Ivory	010332
	Light Almond	010334
	Black	010336
Type A+C 20A, 120V Tamper-Resistant	White	010341
	Ivory	010342
	Light Almond	010344
	Black	010346
Type A+C 20A, 120V Tamper-Resistant w/Night Light	White	010351
	Ivory	010352
	Light Almond	010354
	Black	010356
Dual Type C 20A, 120V	White	010361
	Ivory	010362
	Light Almond	010364
	Black	010366
Dual Type C 20A, 120V Tamper-Resistant	White	010371
	Ivory	010372
	Light Almond	010374
	Black	010376

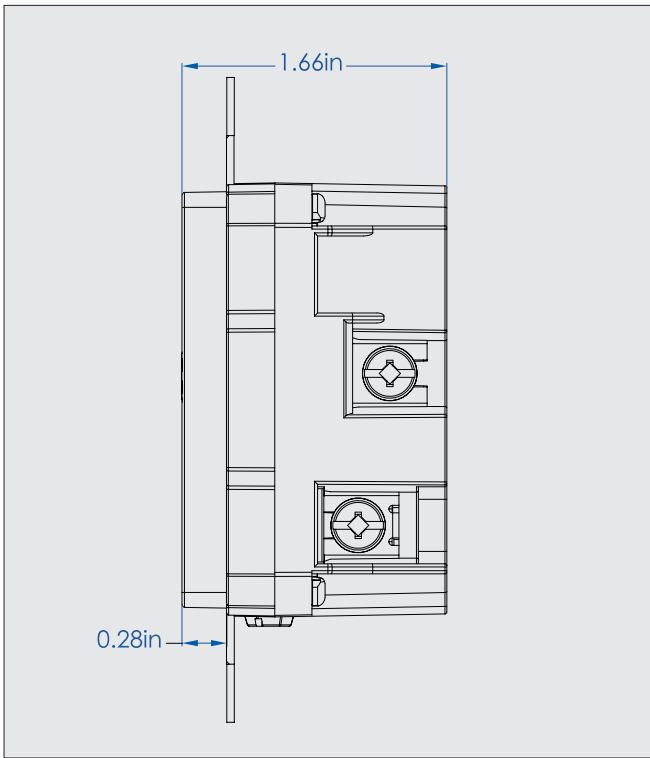
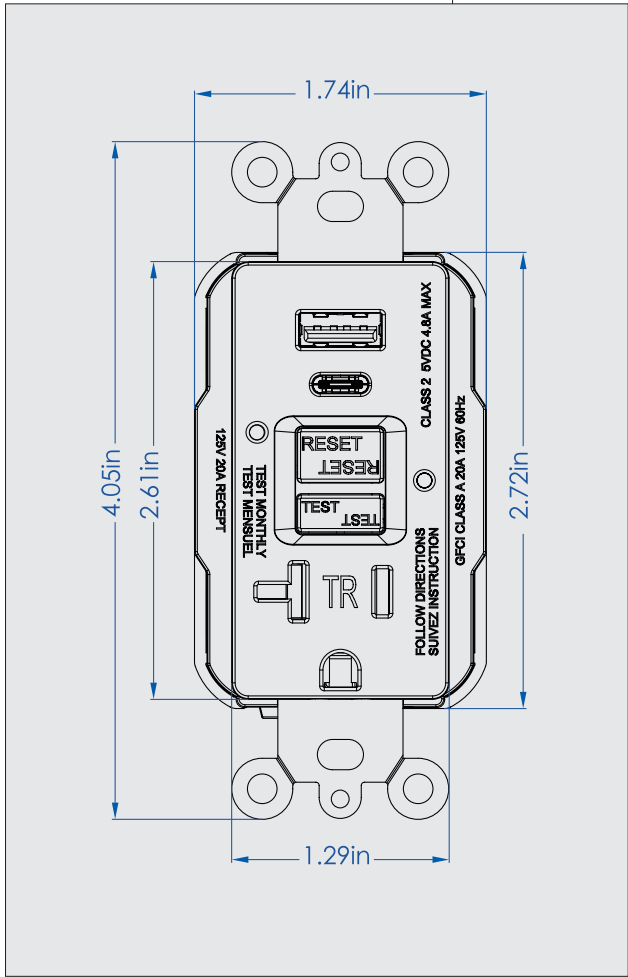

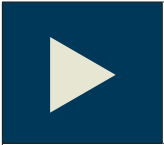

# HIGH-RATE USB RECEPTACLES



All Aida High-Rate USB Receptacles are engineered with two smart chips that automatically recognize and optimize the current and voltage during charging, which ensures faster charging of electronic devices. Backflow Protection prevents electric current flowing back from your devices to the power supply. Additionally, Aida High-Rate USB Receptacles all include protection from overheating where internal heat-sensing system will automatically suspend charging when excessive heat is generated within the USB outlet, preventing the device from being damaged.

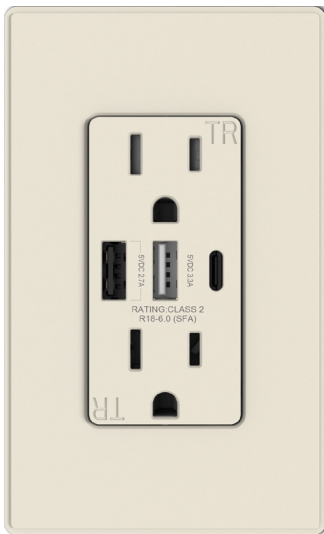

Part# 031104

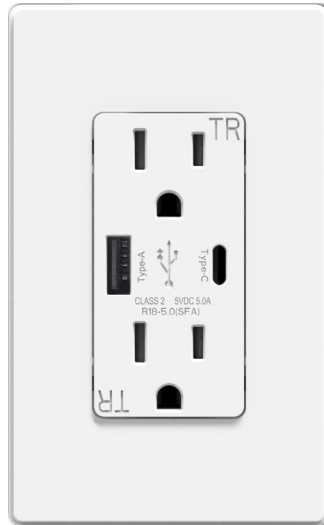





Part# 031071



Part# 031112

All receptacles are offered in the following colors:

	White
	Ivory
	Light Almond
	Black

- > Over-voltage Protection
- > Under-voltage Protection
- > Over-current Protection
- > Overload Protection
- > Short Circuit Protection

- **Smart Chips and Faster Charging:** Built-in unique CC/CV modules and smart chips automatically recognize and optimize the current and voltage during charging, which ensures faster charging of electronic devices.
- **Backflow protection:** Prevents electric current flowing back from your devices to the power supply.
- **Prevents overheating:** Heat-sensing system will automatically suspend charging when excessive heat is generated within the USB outlet, preventing electronics from being damaged by overheating.
- Limited 2-year warranty
- Back- and side-wires for easy installation
- Tamper-Resistant
- Wall plate included

USB Type A



USB Type C



HIGH-RATE USB CHARGING PORTS TAMPER-RESISTANT RECEPTACLES		NEMA	RATING	COLOR	PART #
5.0 Amp	Type A + C USB Charging Port 15 Amp Duplex Tamper-Resistant	5-15R 	15A, 125V	White Ivory Light Almond Black	031071 031072 031074 031076
	Type A + C USB Charging Port 20 Amp Duplex Tamper-Resistant	5-20R 	20A, 125V	White Ivory Light Almond Black	031081 031082 031084 031086
5.4 Amp	Dual Type A USB Charging Port 15 Amp Duplex Tamper-Resistant	5-15R 	15A, 125V	White Ivory Light Almond Black	031111 031112 031114 031116
	Dual Type A USB Charging Port 20 Amp Duplex Tamper-Resistant	5-20R 	20A, 125V	White Ivory Light Almond Black	031121 031122 031124 031126
6.0 Amp	Type A + C USB Charging Port 15 Amp Duplex Tamper-Resistant	5-15R 	15A, 125V	White Ivory Light Almond Black	031101 031102 031104 031106
	Type A + A + C USB Charging Port 20 Amp Duplex Tamper-Resistant	5-20R 	20A, 125V	White Ivory Light Almond Black	031091 031092 031094 031096
30 WATT Quick Charge 3.0 Power Delivery 3.0	Dual Type C USB Charging Ports   15 Amp Tamper-Resistant Duplex Receptacle	5-15R 	15A, 125V	White Ivory Light Almond Black	031301 031302 031304 031306
	Dual Type C USB Charging Ports   20 Amp Tamper-Resistant Duplex Receptacle	5-20R 	20A, 125V	White Ivory Light Almond Black	031311 031312 031314 031316
	Type A+C USB Charging Ports   15 Amp Tamper-Resistant Duplex Receptacle	5-15R 	15A, 125V	White Ivory Light Almond Black	031321 031332 031324 031326
	Type A+C USB Charging Ports   20 Amp Tamper-Resistant Duplex Receptacle	5-20R 	20A, 125V	White Ivory Light Almond Black	031331 031332 031334 031336
36 WATT Quick Charge 3.0 Power Delivery 3.0	Dual Type C USB Charging Ports   15 Amp Tamper-Resistant Duplex Receptacle	5-15R 	15A, 125V	White Ivory Light Almond Black	031281 031282 031284 031286
	Dual Type C USB Charging Ports   20 Amp Tamper-Resistant Duplex Receptacle	5-20R 	20A, 125V	White Ivory Light Almond Black	031291 031292 031294 031296

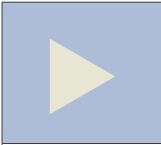

# USB POWER ADAPTERS



Developed, and perfectly fitted for use in older homes and offices needing to convert 2-prong outlets into 3-prong outlets. Aida power adapters include an extendable metal grounding lug at the bottom which can be pulled out and connected to the screw of the wall plate providing proper grounding for safety.

CONFIGURATION	IMAGE	NEMA	RATING	INPUT/OUTPUT	PART #
Power Adapter w/Extendable Grounding Lug		5-15R	100 ~ 125VAC 15A, 1875W	Indoor Use Only	120201
Dual Type A USB Wall Charger Double Outlet Converter w/ Extendable Grounding Lug 4.2 Amp		5-15R	100 ~ 125VAC 15A, 1875W	USB Input:100 ~ 125VAC 60HZ, 0.5A MAX USB output:5V 4.2A 2.4A MAX Per Port	120211
Dual Type A & Type C USB Wall Charger Double Outlet Converter w/ Extendable Grounding Lug 4.2 Amp		5-15R	100 ~ 125VAC 15A, 1875W	USB Input:100 ~ 125VAC 60HZ,0.5A MAX USB output:5V 4.2A 2.4A MAX for Type A 3.0A MAX for Type C	120221
Dual Type A USB Wall Charger Double Outlet Converter 4.2 Amp		5-15R	100 ~ 125VAC 15A, 1875W	USB Input:100 ~ 125VAC 60HZ,0.5A MAX USB output:5V 4.2A 2.4A MAX Per Port	120231
Dual Type A &Type C USB Wall Charger Double Outlet Converter 4.2 Amp		5-15R	100 ~ 125VAC 15A, 1875W	USB Input:100 ~ 125VAC 60HZ,0.5A MAX USB output:5V 4.2 2.4A MAX for Type A 3.0A MAX for Type C	120241
Dual Type A & Type C USB Wall Charger Travel Adapter 4.2 Amp		5-15R	100 ~ 250VAC 15A, 1875W	USB Input:100 ~ 250VAC 60HZ,0.5A MAX USB output:5V 4.2A 2.4A MAX for Type A 3.0A MAX for Type C	120251

# ▶ PORTABLE GFCI DEVICES



All Aida portable GFCI units provide electrical shock protection for people in all work environments while also protecting tools and equipment from damage. These portable GFCI units offer protection for 2-Wire or 3-Wire appliances and tools. In-line GFCI units can be added to or replace a GFCI plug on any power tool or equipment with an electrical cord. The power indicator light turns green when ON. Self-tested every 5 seconds to meet UL latest standards.

### Testing Compliance

- NEMA 3R Rainproof tested
- Trip level 4-6 mA
- Rated for indoor and outdoor use
- UL and cUL listed
- The TEST and RESET buttons allow for periodic testing

\*Service, Junior, Thermoplastic, Weather-Resistant (SJTW) | American Wire Gauge (AWG)



Part # 010531



Part # 010611



Part # 010631

CONFIGURATION	CORD GAUGE	CORD LENGTH	POWER UP TYPE	COLOR	PART #
2-Pole, 3-Wire Grounding, NEMA 5-15, 125V, 60Hz	SJTW 12/3 AWG	2ft	Auto Reset	Yellow Shell Black Button	010511
	SJTW 12/3 AWG	3ft	Manual Reset	Yellow Shell Black Button	010531
In-line GFCI, 2-Pole, 3-Wire Grounding, NEMA 5-15, 125V, 60Hz	SJTW 12/3 AWG	2ft	Auto Reset	Yellow Shell Black Button	010611
	SJTW 12/3 AWG	2ft	Auto Reset	Yellow Shell Black Button	010612
	SJTW 14/3 AWG	3ft	Manual Reset	Yellow Shell Black Button	010631

CONFIGURATION	RATING	RESET	COLOR	PART #
15 Amp GFCI Adapter Outlet	125V, 60Hz	Auto Reset	Yellow	010521
15 Amp GFCI Adapter Outlet	125V, 60Hz	Manual Reset	Yellow	010541



Part # 010541



# POWER DEVICES



Built from durable thermoplastic, Aida power devices are available in flush mount and surface mount versions and come equipped with heavy-gauge, double-wire copper alloy con-tacts. Terminals have ID markings to ensure correct and speedy wiring. Flush mount receptacles fit the wide range of Aida built wall plates with mounting screws included. Angle plugs are made of tough, heavy-duty nylon for a long, dependable service life.



Part # 030676



Part # 030736



Part # 030766

## Aida Power Devices

- Heavy-gauge, double-wire copper alloy contacts
- Easy-to-wire terminals accept up to #4 AWG conductors
- Terminals marked for easy identification and fast wiring
- All mounting hardware included
- Flush-mount devices fit single or two-gang outlet boxes
- Surface-mount devices are commercial grade
- Concentric knockouts for 3/4" and 1" conduit and adjustable cord clamp for back and bottom entrance of cable



Part # 030656

## Aida Angle Plugs

- Made of tough, heavy-duty nylon for long service life
- Devices feature heavy-sectioned dead-front right-angle
- Pressure-clamp terminal design
- Terminals accept up to #4 AWG stranded conductors
- Four-way positioning front module
- Solid brass blades for maximum conductivity

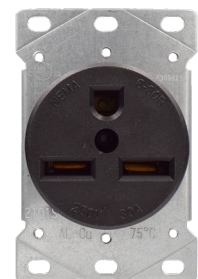

Part # 030606

FLUSH MOUNT POWER OUTLET		NEMA		RATING	WIRING TYPE	PART #
30 Amp Flush Mount Power Outlet	6-30R			30A, 250V	2-Pole, 3-Wire	030606
50 Amp Flush Mount Power Outlet	6-50R			50A, 250V	2-Pole, 3-Wire	030616
30 Amp Flush Mount Dryer Outlet	10-30R			30A, 125V/250V	3-Pole, 3-Wire	030626
50 Amp Flush Mount Range Outlet	10-50R			50A, 125V/250V	3-Pole, 3-Wire	030636
30 Amp Flush Mount Dryer Outlet - White	14-30R			30A, 125V/250V	3-Pole, 4-Wire	030646
50 Amp Flush Mount Range Outlet - White	14-50R			50A, 125V/250V	3-Pole, 4-Wire	030656
30 Amp Flush Mount Travel Trailer Outlet	TT-30R			30A, 125V	2-Pole, 3-Wire	030666
SURFACE MOUNT POWER OUTLET		NEMA		RATING	WIRING TYPE	PART #
30 Amp Grounding Surface Mount Power Outlet	6-30R			30A, 250V	2-Pole, 3-Wire	030676
50 Amp Grounding Surface Mount Power Outlet	6-50R			50A, 250V	2-Pole, 3-Wire	030686
30 Amp Surface Mount Power Outlet	10-30R			30A, 125V/250V	3-Pole, 3-Wire	030696
50 Amp Surface Mount Power Outlet	10-50R			50A, 125V/250V	3-Pole, 3-Wire	030706
30 Amp Grounding Surface Mount Power Outlet	14-30R			30A, 125V/250V	3-Pole, 4-Wire	030716
50 Amp Grounding Surface Mount Power Outlet	14-50R			50A, 125V/250V	3-Pole, 4-Wire	030726
ANGLE PLUG		NEMA		RATING	WIRING TYPE	PART #
30/50 Amp 3-Prong Plug	6-30P & 6-50P			30A/50A, 250V	2-Pole, 3-Wire	030736
30/50 Amp 3-Prong Plug	10-30P & 10-50P			30A/50A, 125V/250V	3-Pole, 3-Wire	030746
30/50 Amp 4-Prong Plug	14-30P & 14-50P			30A/50A, 125/250V	3-Pole, 4-Wire	030756
30 Amp Power Outlet Angle Plug	18-30P			30A, 120/208V	4-Pole, 4-Wire	030846
50 Amp Power Outlet Angle Plug	18-50P			50A, 120/208V	4-Pole, 4-Wire	030856
60 Amp Power Outlet Angle Plug	18-60P			60A, 120/208V	4-Pole, 4-Wire	030866
TRAVEL TRAILER PLUG		NEMA		RATING	WIRING TYPE	PART #
30 Amp Travel Trailer Plug	TT-30P			30A, 125V	2-Pole, 3-Wire	030766
30 Amp Travel Trailer Plug	TT-30P			30A, 120V	2-Pole, 3-Wire	030776



Part # 040056



Part # 040146



Part # 040556



Part # 040586

# LOCKING DEVICES



Aida locking devices are built to provide unparalleled quality and superior performance in the most severe industrial settings. Aida combines the best materials available with superior production standards to produce a broad selection of locking devices of unmatched flexibility and dependability.

- Super tough nylon body resists damage from severe impact, abrasion and chemicals
- Ergonomic, fluted body design with radial grip ridge is ideal for gripping, turning and pulling
- Back-Wire terminal clamps for easy secure wiring
- One-piece, rivet-less 0.035" thick brass connector contacts and solid brass plug blades provide maximum conductivity and long service life

LOCKING PLUGS	NEMA	RATING	WIRING TYPE	PART #
30 Amp Locking Plug	L5-30P	30A, 125V	2-Pole, 3-Wire	040056
30 Amp Locking Plug	L6-30P	30A, 250V	2-Pole, 3-Wire	040116
20 Amp Locking Plug	L14-20P	20A, 125V/250V	3-Pole, 4-Wire	040136
20 Amp Locking Plug	L6-20P	20A, 250V	2-Pole, 3-Wire	040166
20 Amp Locking Plug	L5-20P	20A, 125V	2-Pole, 3-Wire	040156
30 Amp Locking Plug	L14-30P	30A, 125V/250V	3-Pole, 4-Wire	040196
LOCKING CONNECTORS	NEMA	RATING	WIRING TYPE	PART #
20 Amp Locking Connector	L5-20C	20A, 125V	2-Pole, 3-Wire	040046
30 Amp Locking Connector	L5-30C	30A, 125V	2-Pole, 3-Wire	040066
20 Amp Locking Connector	L6-20C	20A, 250V	2-Pole, 3-Wire	040106
30 Amp Locking Connector	L6-30C	30A, 250V	2-Pole, 3-Wire	040126
20 Amp Locking Connector	L14-20C	20A, 125/250V	3-Pole, 4-Wire	040146
30 Amp Locking Connector	L14-30C	30A, 125V/250V	3-Pole, 4-Wire	040206
LOCKING RECEPTACLES	NEMA	RATING	WIRING TYPE	PART #
30 Amp Locking Receptacle	L5-30R	30A, 125V	2-Pole, 3-Wire	040546
30 Amp Locking Receptacle	L6-30R	30A, 250V	2-Pole, 3-Wire	040556
20 Amp Locking Receptacle	L14-20R	20A, 125V/250V	3-Pole, 4-Wire	040566
20 Amp Locking Receptacle	L6-20R	20A, 250V	2-Pole, 3-Wire	040576
30 Amp Locking Receptacle	L14-30R	30A, 125V/250V	3-Pole, 4-Wire	040586
20 Amp Locking Receptacle	L5-20R	20A, 125V	2-Pole, 3-Wire	040596



# TWIST-LOCK INLET PLUGS & RECEPTACLES

The Aida Twist-lock Inlet Plugs, and Outlet Receptacles are suitable for heavier electrical load requirements such as in RVs, campers, and shore power, allowing a weatherproof connection between vessels and external power sources. Securely locking the plug into place with the twist-lock feature prevents accidental disconnection during use.



TWIST-LOCK PLUGS	NEMA	RATING	WIRING TYPE	PART #
30 Amp Travel Trailer Twist-Lock	TT-30P	125V	2-Pole, 3-Wire, Grounding	030966
30 Amp Twist-Lock	L5-30P	125V	2-Pole, 3-Wire, Grounding	040315
30 Amp Twist-Lock	L6-30P	250V	2-Pole, 3-Wire, Grounding	040325
30 Amp Twist-Lock	L14-30P	125V/250V	2-Pole, 3-Wire, Grounding	040335
50 Amp Ship-to-Shore Twist-Lock	SS2-50P	125V/250V	3-Pole, 4-Wire, Grounding	040345
TWIST-LOCK RECEPTACLES	NEMA	RATING	WIRING TYPE	PART #
30 Amp Twist-Lock	L5-30C	125V	2-Pole, 3-Wire	040275
30 Amp Twist-Lock	L6-30C	250V	2-Pole, 3-Wire	040285
20 Amp Twist-Lock	L14-20C	125V/250V	3-Pole, 4-Wire	040295
30 Amp Twist-Lock	L14-30C	125V/250V	3-Pole, 4-Wire	040305



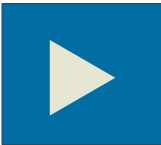

# CHARGING OUTLETS

NEW!



Aida Charging Outlets are built tough for heavy, everyday use—perfect for appliances, RVs, EVs, generators, welders, and more. Designed for harsh outdoor durability, they're weatherproof, dust-proof, and waterproof—far more reliable than rust-prone metal boxes. Crafted from high-impact ABS plastic, each charging outlet offers a snug, secure fit and long-lasting resistance to wear and corrosion. Installation is fast and simple, with clear step-by-step instructions included. Choose any configuration—every model is priced the same. Whether you're at home, on the move, or powering a project, Aida ensures safe, dependable performance wherever you plug in.

WIRING	NEMA	WIRING DIAGRAM	AMP	VOLTAGE	PART #
2-Pole, 3-Wire, GXY, Grounding	6-30R		30 Amp	250V	030608
2-Pole, 3-Wire, GXY, Grounding	6-50R		50 Amp	250V	030618
3-Pole, 3-Wire, WXY	10-30R		30 Amp	125V/250V	030628
3-Pole, 3-Wire, WXY	10-50R		50 Amp	125V/250V	030638
3-Pole, 4-Wire, GWXY, Grounding	14-30R		30 Amp	125V/250V	030648
3-Pole, 4-Wire, GWXY, Grounding	14-50R		50 Amp	125V/250V	030668
3-Pole, 3-Wire GWX, Grounding	TT-30R		30 Amp	125V	030658
4-Pole, 4-Wire, GWXY, Grounding	L14-30R Twist-Lock		30 Amp	125V/250V	040305





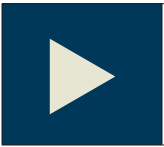

# DECORATIVE SWITCHES



Part # 020371



Part # 020404



Part # 020422



Part # 020301

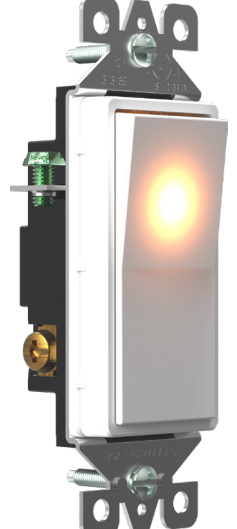

Part # 020321

- Switch frame shields against dust and fits in wall plate to prevent rocker binding
- Back and side wiring terminals accept both solid and stranded wire to ease installation
- Virtually unbreakable, ultrasonically welded top and back body
- Sturdy construction for long service life
- Tri-combo screws accept slotted, Phillips, and Robertson-head tools
- Easy-access ground screws



DECORATIVE RESIDENTIAL	RATING	WIRING	COLOR	PART #
Single-Pole Switch	15A, 120V/277V	Push-Wire & Side-Wire	White Ivory Light Almond Black	020371 020372 020374 020376
3-Way Switch		Push-Wire & Side-Wire	White Ivory Light Almond Black	020401 020402 020404 020406
4-Way Switch		Side-Wire	White Ivory Light Almond Black	020421 020422 020424 020426
DECORATIVE RESIDENTIAL WITH LIGHT	RATING	WIRING	COLOR	PART #
Single-Pole Switch	15A, 120V/277V	Push-Wire & Side-Wire	White Ivory Light Almond	020081 020082 020084
3-Way Switch		Push-Wire & Side-Wire	White Ivory Light Almond	020321 020322 020324
DECORATIVE COMMERCIAL	RATING	WIRING	COLOR	PART #
Single-Pole Switch	20A, 120V/277V	Back-Wire & Side-Wire	White Ivory Light Almond Black	020281 020282 020284 020286
3-Way Switch		Back-Wire & Side-Wire	White Ivory Light Almond Black	020301 020302 020304 020306



# ▶ TOGGLE SWITCHES

RESIDENTIAL TOGGLE SWITCH	RATING	WIRING	COLOR	PART #
Single-Pole Switch	15A, 120V	Push-Wire & Side-Wire	White Ivory Light Almond Black	020011 020012 020014 020016
3-Way Switch	15A, 120V	Push-Wire & Side-Wire	White Ivory Light Almond Black	020041 020042 020044 020046
4-Way Switch	15A, 120V/277V	Side-Wire	White Ivory Light Almond Black	020071 020072 020074 020076
(Other) Feed-Through Cord Switch	6A, 120V	Feed-Through	Ivory	120041
RESIDENTIAL TOGGLE SWITCH WITH LIGHT	RATING	WIRING	COLOR	PART #
Single-Pole Switch	15A, 120V	Push-Wire & Side-Wire	Transparent	020010
3-Way Switch			Transparent	020040
COMMERCIAL TOGGLE SWITCH	RATING	WIRING	COLOR	PART #
Single-Pole Switch	20A, 120V/277V	Back-Wire & Side-Wire	White White Ivory Light Almond Black	020533 020021 020022 020024 020026
3-Way Switch			White Ivory Light Almond Black	020031 020032 020034 020036



Part # 020011



Part # 020042

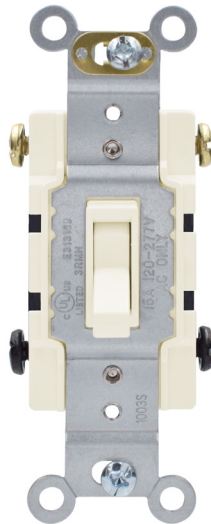

Part # 020074



Part # 020021



Part # 020040

# COMBINATION SWITCHES



Part # 020101

- Switch frame shields against dust and fits in wall plate
- Side-Wire terminations accept both solid and stranded wire for easy installation
- Virtually unbreakable, ultrasonically welded top and back-body
- Sturdy construction for long service life
- Tri-drive screws, accepts slotted Phillips and Robertson-head tools
- Easy-access ground screws

### Testing Compliance

- UL and cUL Listed
- Comply with UL 20
- Meet NEMA WD-1 and WD-6

### Material Characteristic

- Flammability Rating: Rated V-2 per UL 94
- Temperature Rating: -40°C to 60°C (-40°F to 140°F)
- Meet NEMA WD-1 and WD-6



Part # 020181



Part # 020121



Part # 020191



Part # 020411

RESIDENTIAL COMBINATION SWITCH	RATING	WIRING	COLOR	PART #
15 Amp Single-Pole Horizontal Duplex Toggle Switch	15A, 120V	Back-Wire & Side-Wire	White	020101
15 Amp Toggle Switch and Tamper-Resistant Receptacle			White	020111
15 Amp Single-Pole Horizontal Duplex Decorative Wall Switch			White	020121
15 Amp Single-Pole Toggle Switch & Wide Pilot Light			White	020181
15 Amp Single-Pole Decorative Wall Switch & Pilot Light			White	020191
15 Amp Three Single-Pole Decorative Wall Switch			White	020411



# LIGHTING CONTROLS & DIMMERS



Aida lighting control devices deliver high performance and reliability you've come to expect and are the ideal tool to help create the perfect ambiance within a room and help conserve electricity to reduce overall energy costs.

- Compatible with 99% of light bulbs on the market
- High strength tempered glass and ultra-clear LCD screen
- The integrated Smart System remembers previous settings
- Power Saving mode after 5 seconds of inactivity - touch any key to wake
- Mechanical backup switch conforms with UL Standards

Part # 080013



Part # 080011



Part # 070011

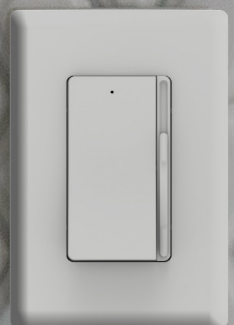



CATEGORY	TOUCH PANEL DIMMERS	RATING	LOAD CAPACITY	COLOR	PART #
Touch Panel	White Panel with White Plastic Wall Plate	120V, 60Hz	Incandescent light bulb 600W, CFL 300W, LED 300W/120V	White	080022
	Black Panel with Black Plastic Wall Plate			Black	080021
CATEGORY	TOGGLE & PUSH PANEL DIMMERS	RATING	LOAD CAPACITY	COLOR	PART #
Toggle Switch	Digital Slide Bar Dimmer, Single-pole, 3-Way Combination   Wall Plate Sold Separately	120V, 60Hz	Incandescent light bulb 600W, CFL 150W, LED 150W/120V	White	080041
Push Switch	Digital Rotary Dimmer, Single-Pole 3-Way Combination   Wall Plate Sold Separately	120V, 60Hz		White	080051
	Digital Rotary Dimmer with LED Indicating light, Single-Pole, 3-Way Combination   Wall Plate Sold Separately	120V, 60Hz		White	080091
	Rotary Dimmer, Single-Pole 3-Way Combination   Wall Plate Sold Separately	120V, 60Hz		White	080061
	Rotary Dimmer with LED Indicating light, Single-Pole, 3-Way Combination   Wall Plate Sold Separately	120V, 60Hz		White	080101



Part # 080013

- Adjustable initial brightness setting for different type of lights
- Compatible with 99% of light bulbs on the market today
- Tough thermoplastic housing is impact and scratch-resistant
- Ultra low current harmonic to protect your devices from electromagnetic interference
- Ergonomic design for comfortable and intuitive touch control
- Energy saving and long operating life
- Single-Pole/3-Way combination
- Conforms with UL 1472

- 270° precise adjustment of initial brightness
- Power switch sits flush and level with plate surface when switch is OFF
- Hap-tic feedback at 50% brightness
- Three replaceable wall plate color options - snap in/out for simple replacement
- Single-Pole/3-Way combination



Part # 080011



Part # 070011

- Low-noise and high-sensitivity
- Automatic ON or Manual ON is optional
- Automatic OFF
- 180° coverage up to 900 sq. ft.
- Adjustable sensitivity from 20% to 100%
- Adjustable time delay from 30 seconds to 30 minutes
- Pet detection (reduce false triggers)
- Adjusts brightness to changes in ambient lighting
- Three replaceable wall plate color options - snap in/out for simple replacement

SENSOR	RATING	LOAD CAPACITY	COLOR	PART #
Occupancy Sensor with 3 Wall Plate Options	120V/277V, 60Hz	Incandescent Light Bulb 600W, CFL300W, LED300W	White, Ivory, Light Almond	070011
Vacancy Sensor with 3 Wall Plate Options			White, Ivory, Light Almond	070021
DIMMER	RATING	LOAD CAPACITY	COLOR	PART #
Rocker Dimmer with 3 Wall Plate Options Single-Pole/3-Way Combination	125V, 60Hz	Incandescent Light Bulb 600W, CFL300W, LED300W/120V.	White, Ivory, Light Almond	080013
Slide Dimmer with 3 Wall Plate Options Single-Pole/3-Way Combination	120V, 60Hz	Incandescent Light Bulb 600W, CFL150W, LED150W/120V.	White, Ivory, Light Almond	080011





# WALL PLATES



Aida quality wall plates are created from thermoplastic, thermoset plastic, metal and stainless steel. Their super heavy-duty construction provides outstanding performance in a wide range of applications. Available in different sizes, Aida wall plates are designed and manufactured according to the UL Standard 514. The dimensional characteristics are designed with high specificity, both for performance needs and for compatibility with devices and outlet boxes

### Thermoplastic and Thermoset Wall Plates

- Smooth finish for easy cleaning and attractive appearance
- High quality wall plates meet or exceed all industry standards
- Captive mounting screws to save installation time
- Thermoplastic wall plates are virtually unbreakable, with high structural rigidity, longterm form retention, and superior impact and abrasion resistance

### Testing Compliance

- UL 514D and cUL listed for thermoplastic and thermosetting wall plate
- ETL and cETLus listed for stainless steel and metal wall plate
- Meets all UL514 and CSA requirements
- Meets all ETL, cETLus, and CSA requirements



Part # 051111



Part # 051321



Part # 051721

THERMOPLASTIC WALL PLATES	STANDARD SIZE (4.5" H X 2.75" W) PART #	MID- SIZE (4.9" H X 3.125" W) PART #	JUMBO (5.5" H X 3.5" W) PART #	COLOR
1-Gang Decorative Wall Plate	051312	051361	051391	White
	051311	051362	051392	Ivory
	051314	051363	051393	Light Almond
	051316	051364	051394 (Coming in 2025)	Black
2-Gang Decorative Wall Plate	051321	051371	051401	White
	051322	051372	051402	Ivory
	051324	051373	051403	Light Almond
	051326	051374	051404 (Coming in 2025)	Black
3-Gang Decorative Wall Plate	051331	051381		White
	051332	051382		Ivory
	051334	051383		Light Almond
	051336	051384 (Coming in 2025)		Black
4-Gang Decorative Wall Plate	051751			White
	051752			Ivory
	051753			Light Almond
	051754 (Coming in 2025)			Black
1-Gang Blank Wall Plate	051411	051431	051451	White
	051412	051432	051452	Ivory
	051414	051433	051453	Light Almond
	051416	051434	051454 (in 2025)	Black
2-Gang Blank Wall Plate	051421	051441		White
	051422	051442		Ivory
	051424	051443		Light Almond
	051426	051444 (in 2025)		Black

**THERMOPLASTIC UNBREAKABLE WALL PLATES**

<b>TOGGLE SWITCH WALL PLATE</b>	<b>STANDARD SIZE (4.5"H X 2.75"W) PART #</b>	<b>MID-SIZE (4.9"H X 3.125"W) PART #</b>	<b>LARGE (5.25"H X 3.25"W) PART #</b>	<b>JUMBO (5.5"H X 3.5"W) PART #</b>	<b>COLOR</b>
1-Gang Toggle Switch	051111 051112 051114 051116	051151 051152 051153 051154	051181 051182 051183 051184 (in 2025)		White Ivory Light Almond Black
2-Gang Toggle Switch	051121 051122 051124 051126	051161 051162 051163 051164		051191 051192 051193 051194 (in 2025)	White Ivory Light Almond Black
3-Gang Toggle Switch	051131 051132 051134 051136	051171 051172 051173 051174			White Ivory Light Almond Black
4-Gang Toggle Switch	051141 051142 051143 051144 (in 2025)				White Ivory Light Almond Black
<b>POWER OUTLET WALL PLATE</b>		<b>MID-SIZE PART #</b>		<b>JUMBO PART #</b>	<b>COLOR</b>
1-Gang Single Receptacle				051731 051732 051733 051734 (in 2025)	White Ivory Light Almond Black
2-Gang 30 or 50 Amp Power Outlet		051741 051742 051743 051744 (in 2025)			White Ivory Light Almond Black
1-Gang Single Receptacle	052821 052822 052824				White Ivory Light Almond
<b>DUPLEX RECEPTACLE WALL PLATE</b>	<b>STANDARD PART #</b>	<b>MID-SIZE PART #</b>	<b>LARGE PART #</b>	<b>JUMBO PART #</b>	<b>COLOR</b>
1-Gang Duplex Receptacle	051211 051212 051214 051216	051251 051252 051253 051254	051281 051282 051283 051284		White Ivory Light Almond Black
2-Gang Duplex Receptacle	051221 051222 051224 051226	051261 051262 051263 051264			White Ivory Light Almond Black
<b>COMBINATION WALL PLATE</b>	<b>STANDARD PART #</b>	<b>MID-SIZE PART #</b>			<b>COLOR</b>
2-Gang 1 Toggle Switch & 1 Duplex Receptacle Combination	051711 051712 051714 051716	051721 051722 051723 051724 (in 2025)			White Ivory Light Almond Black
2-Gang 1 Toggle Switch & 1 Decorative Combination	051811 051812 051814 051816	051821 051822 051823 051824 (in 2025)			White Ivory Light Almond Black
2-Gang 1 Duplex Receptacle & 1 Decorative Combination	051911 051912 051914 051916				White Ivory Light Almond Black

## THERMOSET WALL PLATES

TOGGLE SWITCH	COLOR	PART #
1-Gang Toggle Switch	White	052111
	Ivory	052112
	Light Almond	052114
	Black	052116
2-Gang Toggle Switch	White	052121
	Ivory	052122
	Light Almond	052124
	Black	052126
3-Gang Toggle Switch	White	052131
	Ivory	052132
	Light Almond	052134
	Black	052136
DUPLEX RECEPTACLE	COLOR	PART #
1-Gang Duplex Receptacle	White	052211
	Ivory	052212
	Light Almond	052214
	Black	052216
DECORATIVE RECEPTACLE	COLOR	PART #
1-Gang Decorative	White	052311
	Ivory	052312
	Light Almond	052314
	Black	052316
2-Gang Decorative	White	052321
	Ivory	052322
	Light Almond	052324
	Black	052326
3-Gang Decorative	White	052331
	Ivory	052332
	Light Almond	052334
	Black	052336
TOGGLE SWITCH & DUPLEX RECEPTACLE COMBO	COLOR	PART #
2-Gang Toggle Switch & Duplex Receptacle Combination	White	052711
	Ivory	052712
	Light Almond	052714
	Black	052716
TOGGLE SWITCH & DECORATIVE RECEPTACLE COMBO	COLOR	PART #
2-Gang Toggle Switch & Decorative Receptacle Combination	White	052811
	Ivory	052812
	Light Almond	052814
	Black	052816

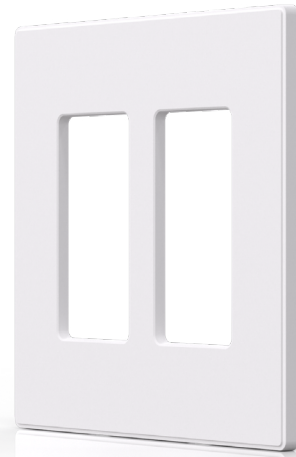

## SCREW-LESS WALL PLATES

PLASTIC WALL PLATE	SIZE	COLOR	PART #
1-Gang Toggle Switch	Mid-Size 4.9"H x 3.12"W	White	053751
		Ivory	053752
		Light Almond	053754
		Black	053756
2-Gang Toggle Switch	Mid-Size 4.9"H x 5"W	White	053761
		Ivory	053762
		Light Almond	053764
		Black	053766
1-Gang Duplex Receptacle	Mid-Size 4.9"H x 3.12"W	White	053771
		Ivory	053772
		Light Almond	053774
		Black	053776
2-Gang Duplex Receptacle	Mid-Size 4.9"H x 5"W	White	053781
		Ivory	053782
		Light Almond	053784
		Black	053786
1-Gang Blank All Coming in 2025	Mid-Size 4.9"H x 3.12"W	White	053941
		Ivory	053942
		Light Almond	053944
		Black	053946
1-Gang Decorative (Straighted Type)	Standard 4.5"H x 2.75"W	White	051341
		Ivory	051342
		Light Almond	051344
		Black	051346
1-Gang Decorative (Straighted Type)	Mid-Size 4.9"H x 3.12"W	White	051461
		Ivory	051462
		Light Almond	051464
		Black	051466
2-Gang Decorative (Straighted Type)	Mid-Size 4.9"H x 5"W	White	051471
		Ivory	051472
		Light Almond	051474
		Black	051476
3-Gang Decorative (Straighted Type)	Mid-Size 4.9"H x 6.75"W	White	051481
		Ivory	051482
		Light Almond	051484
		Black	051486
4-Gang Decorative (Straighted Type) All Coming in 2025	Mid-Size 4.9"H x 5"W	White	051491
		Ivory	051492
		Light Almond	051494
		Black	051496

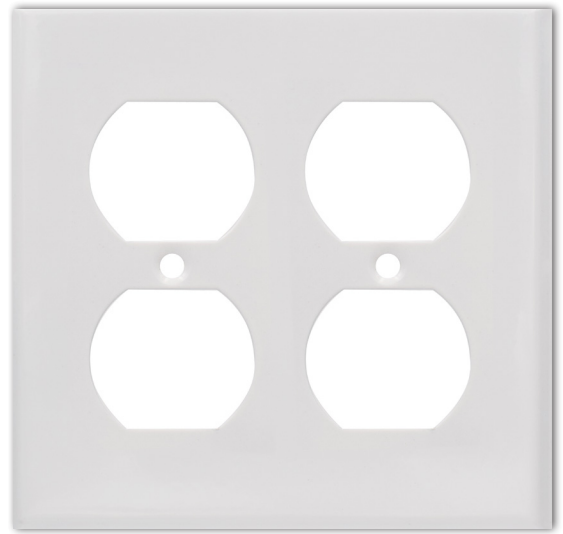

## METAL WALL PLATES

<b>WRINKLE METAL TOGGLE</b>	<b>STANDARD SIZE (4.5"H X 2.75"W) PART #</b>	<b>MID-SIZE (4.9"H X 3.125"W) PART #</b>	<b>JUMBO (5.5"H X 3.5"W) PART #</b>	<b>COLOR</b>
1-Gang Toggle Switch	053112	053122	053132	Ivory
2-Gang Toggle Switch	053142	053152	053162	Ivory
3-Gang Toggle Switch	053172		053192	Ivory
1-Gang Duplex Receptacle	053212	053222	053232	Ivory
2-Gang Toggle Switch & Duplex Receptacle	053712	053722		Ivory
1-Gang Blank Wall plate		053422		Ivory
<b>SMOOTH METAL WALL PLATES</b>	<b>STANDARD SIZE (4.5"H X 2.75"W) PART #</b>	<b>MID- SIZE (4.9"H X 3.125"W) PART #</b>	<b>JUMBO (5.5"H X 3.5"W) PART #</b>	<b>COLOR</b>
1-Gang Toggle Switch	053111	053121	053131	White
2-Gang Toggle Switch	053141	053151	053161	White
3-Gang Toggle Switch	053171		053191	White
1-Gang Phone			053541 053542	White Ivory
1-Gang Single Receptacle	053511	053521	053532	Ivory
1-Gang Duplex Receptacle	053211	053221	053231	White
2-Gang 2 Duplex Receptacles	053241			White
1-Gang Decorative Device	053311	053321	053322 053331	White Ivory
2-Gang Decorative Device	053341			White
1-Gang Blank	053411	053421	053431 053433	White Ivory
2-Gang Blank & Toggle Switch	053011			White
2-Gang Toggle Switch & Duplex Receptacle	053711	053721	053731	White
3-Gang Toggle Switch & Duplex Receptacle			053742	Ivory

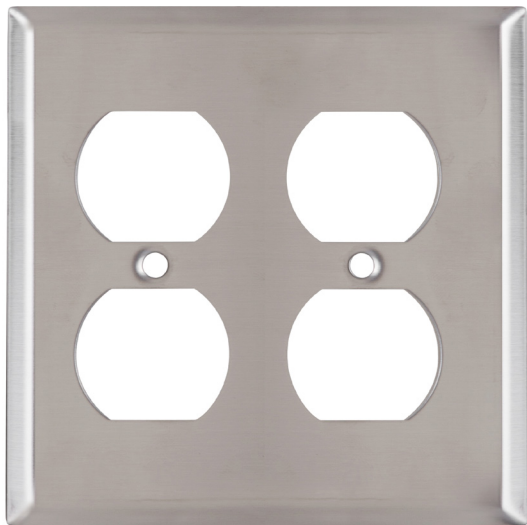

### 304 Stainless Steel Wall Plates

- Superior non-corrosive and non-magnetic properties for applications needing protection from those elements
- Smooth face and rounded edges resist dust accumulation
- Stamped from 0.032" (0.81mm) thick material
- Matching stainless steel mounting screws provided

## STAINLESS STEEL WALL PLATES

STANDARD SIZE ONLY	PART #
1-Gang Stainless Steel Toggle Switch	055111
2-Gang Stainless Steel Toggle Switch	055121
3-Gang Stainless Steel Toggle Switch	055131
1-Gang Stainless Steel Phone Line	055171
3-Gang Stainless Steel Duplex Receptacle	055211
1-Gang Stainless Steel Duplex Receptacle	055221
2-Gang Stainless Steel Duplex Receptacle	055231
1-Gang Stainless Steel Decorative Device	055311
2-Gang Stainless Steel Decorative Device	055321
3-Gang Stainless Steel Decorative Device	055331
1-Gang Stainless Steel Blank	055411
2-Gang Stainless Steel Blank	055421
3-Gang Stainless Steel Blank	055431
1-Gang Stainless Steel Single Power Outlet	055511
2-Gang Stainless Steel Duplex Power Outlet Coming in 2025	055521
1-Gang Stainless Steel Single Receptacle, 1.5938" hole	055610
1-Gang Stainless Steel Single Power Outlet Receptacle	055650
2-Gang Stainless Steel Single Receptacle	055660
2-Gang Stainless Steel Single Power Outlet Recept, 2.156" hole	055671
2-Gang Stainless Steel Single Power Outlet Coming in 2025	055672
2-Gang Stainless Steel Toggle Switch & Duplex Receptacle	055711
3-Gang Stainless Steel Double Toggle Switch & Duplex Receptacle	055712
2-Gang Stainless Steel Toggle Switch & Decorative Device	055811
2-Gang Stainless Steel Power Outlet & Duplex Receptacle Coming in 2025	055818
3-Gang Stainless Steel Double Toggle Switch & Decorative Device	055821
2-Gang Stainless Steel Decorative Device & Duplex Receptacle	055911





# WEATHERPROOF COVERS

**NEW!**



Aida thermoplastic weatherproof covers are designed to protect electrical devices in a variety of outdoor environments, ensuring that your outlets remain shielded from multiple hazards. The self-closing lid made of thermoplastic material, provides resilience and flexibility, making it ideal for withstanding the rigors of outdoor exposure and includes a gasket for a tight seal against water and debris.

THERMOPLASTIC WEATHERPROOF COVER	COLOR	PART #
	1-Gang Vertical Duplex Receptacle	White 110011
	1-Gang Vertical Duplex Receptacle	Gray 110018
	1-Gang Vertical Decorative Receptacle	White 110021
	1-Gang Vertical Decorative Receptacle	Gray 110028
	1-Gang Horizontal Duplex Receptacle with Duplex Cover	White 110031
	1-Gang Horizontal Duplex Receptacle with Duplex Cover	Gray 110038
	1-Gang Horizontal Duplex Receptacle with Single Cover	White 110051
	1-Gang Horizontal Duplex Receptacle with Single Cover	Gray 110058
	1-Gang Horizontal Decorative Receptacle with Single Cover	White 110061
	1-Gang Horizontal Decorative Receptacle with Single Cover	Gray 110068

# WEATHERPROOF IN-USE COVER

WEATHERPROOF COVER	PRODUCT DIMENSIONS	WEIGHT	COLOR	PART #
1-Gang Thermoplastic Weatherproof In-Use Cover	150mm x 119mm x 77.5mm	.485 lbs	Clear and Black	110040

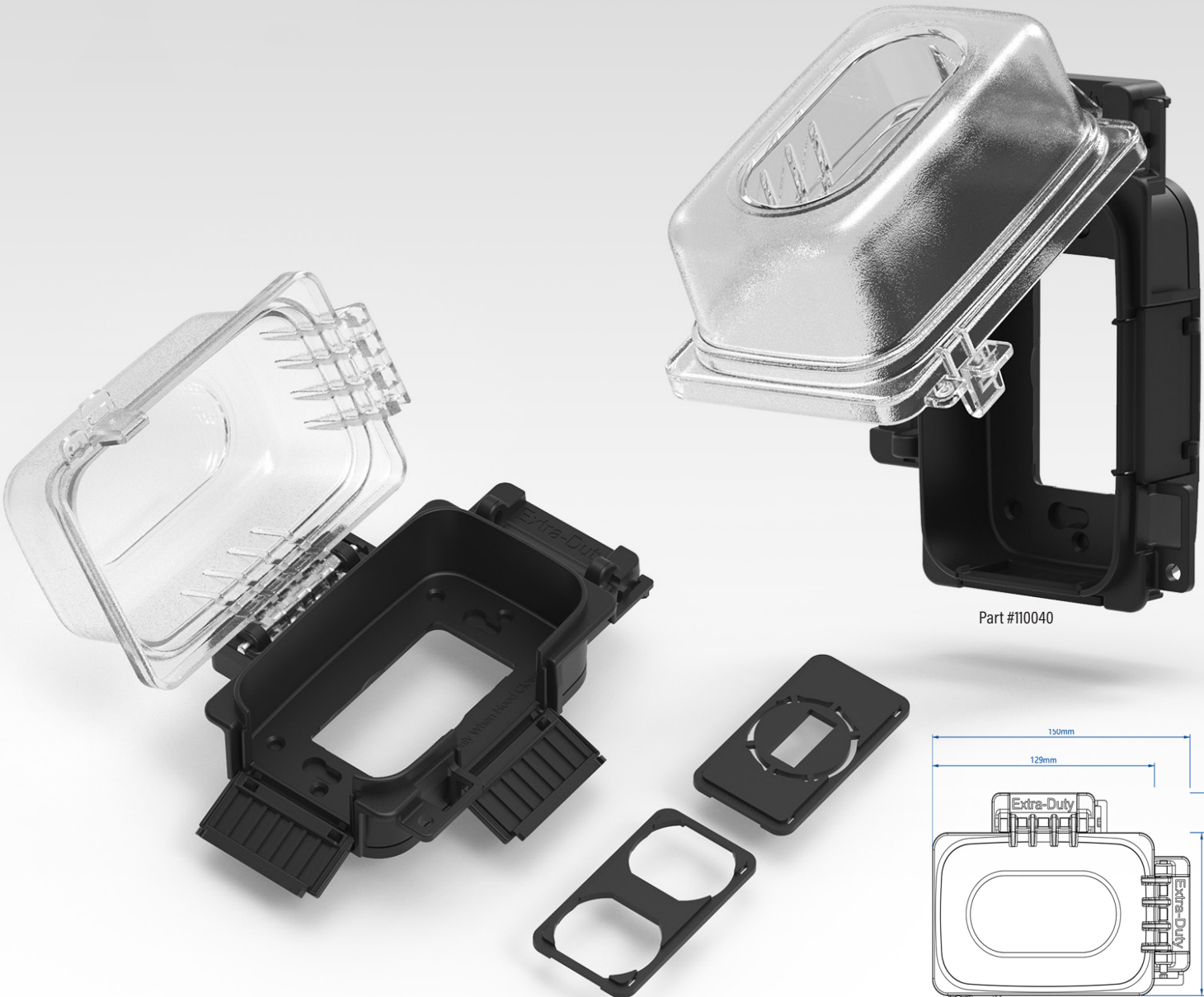

Part #110040

**Product Dimensions:** 150mm\*119mm\*77.5mm  
**Gross Weight:** 0.485 lbs  
**Color:** Clear Cover  
**Material:** Thermoplastic  
**Style:** Single Gang  
**Inside Depth:** 2 - 3/4 Inch  
**Regulatory Approvals:** cULus Listed, NEMA 3R Rated



# WIRE CONNECTORS



AIDA offers a full line of screw-on, winged, and push-in connectors, made with tough thermoplastic.

## Wire Nuts and Winged Connectors

- Tough thermoplastic, UL 94V-2 flame-retardant shell rated at 105°C (221°F)
- Zinc-plated square wire spring ensures a firm grip on conductors
- Specific dented design offers better grip and comfort to ensure better torquing
- Color-coded to industry standards for quick size identification
- Rated to 600V max. for building wiring and 1000V max. in lighting fixtures/ luminaries and signs
- UL 486C Listed and CSA C22.2 No. 188



SCREW-ON WIRE NUTS	COLOR	PART #
100/box	Gray	120053
100/box	Blue	120054
100/box 500/bag	Orange	120056 120055
100/box 500/bag 200/jar	Yellow	120058 120057 120059
500	Red	120060
SCREW-ON/WINGED	COLOR	PART #
50/box	Blue	120066
100/box 500/bag	Red	120065 120082
100/box 500/bag	Tan	120064 120063
100/box 500/bag	Yellow	120062 120061
500/bag 150/jar	Green	120067 120068
PUSH-IN	COLOR	PART #
100/box	Yellow	120070
100/box	Orange	120072
75/box	Clear	120074
50/box	Blue	120076
50/box	Purple	120078
40/box	Black	120080

## Push-In Connectors

- Polycarbonate, UL 94V-0 flame-retardant shell, rated at T85 (IEC), 105°C (221°F) (UL)
- Spring force connector constructed from tinned copper plate and stainless steel spring
- Double-spring construction ensures secure electrical conductivity
- Color-coded clear shell offers visual verification of connection
- Rated to 600V max. for building wiring and 1000V max. in lighting fixtures/luminaries and signs
- Recommend reusing with a wire at least one size larger than the wire previously removed
- IEC/EN 60998 Certified and UL 486C Listed





# LAMP HOLDERS & SOCKETS



IMAGE	ITEM	RATING	COLOR	PART #
	Light Socket	600V, 660W	Black	120011
	Plug-in Socket Adapter	125V, 660W	Ivory	120012
	3-Way Socket Lamp Holder	250V, 250W	Golden	120013
	Push-Button Socket Lamp Holder	250V, 660W	Golden	120014
	Turn-Knob Socket Lamp Holder	250V, 250W	Golden	120015
	Pull-Chain Socket Lamp Holder	250V, 660W	Golden	120016
	Key-less Socket Adapter	125V, 660W	Ivory	120021
	Socket Adapter with Pull Chain	125V, 660W	Ivory	120022
	Socket Adapter with Pull Chain	125V, 660W	Black	120023
	Dual Socket Adapter	250V, 660W	Ivory	120024
	Socket Adapter	125V, 660W	Black	120025
	Plastic Lamp holder	250V, 660W	White	120045
	Plastic Pull Chain Lamp holder	250V, 660W	White	120046
	Plastic Pull Chain Lamp holder with Socket	125V,15A, 660W	White	120047



Part # 120045



Part # 120015



Part # 120023

# ADAPTERS & CONNECTORS

Aida offers a full line of grounded and ungrounded outlet adapters and lamp holders, all manufactured from high-impact resistant thermoplastics for durability and long-term performance. Each complies with relevant UL 1449 requirements.

IMAGE	ADAPTERS	NEMA	RATING	COLOR	PART #
	15 Amp 2-Wire Single-to-Single Grounding Outlet Adapter 2/pack	1-15P 5-15R	15A, 125V	Gray	120031 2 Pack
	15 Amp 3-Wire Single-to-Six Grounding Outlet Adapter	5-15P 5-15R	15A, 125V	White	120032
	15 Amp 3-Wire Single-to-Triple Grounding Outlet Adapter	5-15P 5-15R	15A, 125V	White	120033
	15 Amp 2-Wire Single-to-Triple Outlet Adapter	1-15P 1-15R	15A, 125V	White	120034
	15 Amp 3-Wire Single-to-Triple Grounding Outlet Adapter	1-15P 5-15R	15A, 125V	Ivory	120035
	15 Amp 3-Wire Single-to-Triple Grounding Outlet Adapter	5-15P 5-15R	15A, 125V	Orange	120036
	15-Amp 3-Wire Single-to-Triple Grounding Outlet Adapter Multi-direction	5-15P 5-15R	15A, 125V	Orange	120037
	15 Amp 2-Wire Single-to-Single Cube Outlet Adapter with Tap-to-light Switch		15A, 125V	White	120039 Coming in 2025
	15-Amp 2-Wire Single-to-Triple Polarized Swivel Outlet Adapter		15A, 125V	White	120051
	15-Amp 3-Wire Single-to-Triple Grounding Outlet Swivel Adapter		15A, 125V	White	120052
IMAGE	PLUGS & CONNECTORS AVAILABLE AS 10-PACK	NEMA	RATING	COLOR	PART #
	3-Prong Straight Blade Plug	5-15P 	15A, 125V	Yellow	052660 10 Pack
	3-Wire Straight Blade Connector	5-15R 	15A, 125V	Yellow	052690 10 Pack

# NEW AIDA PRODUCTS COMING IN 2025

DESCRIPTION	PAGE #	COLOR	PART #
15 Amp TR Toggle Switch & Receptacle Combination	26	White	020111
30 Amp Twist-Lock Travel Trailer Outlet Receptacle	21	Green	030966
30 Amp Twist-Lock Outlet Receptacle	21	Green	040275
30 Amp Twist-Lock Outlet Receptacle	21	Green	040285
30 Amp Twist-Lock Outlet Receptacle	21	Green	040305
30 Amp Twist-Lock Outlet Receptacle	21	Green	040315
30 Amp Twist-Lock Outlet Receptacle	21	Green	040325
30 Amp Twist-Lock Outlet Receptacle	21	Green	040335
50 Amp Twist-Lock Outlet Receptacle SS2	21	Green	040345
4-Gang Thermoplastic Toggle Switch Wall Plate   Standard Size	33	Matte Black	051144
1-Gang Thermoplastic Toggle Switch Wall Plate   Jumbo Size	33	Matte Black	051184
2-Gang Thermoplastic Toggle Switch Wall Plate   Large Size	33	Matte Black	051194
3-Gang Thermoplastic Decorative Wall Plate   Mid-Size	32	Matte Black	051384
1-Gang Thermoplastic Decorative Wall Plate   Jumbo Size	32	Matte Black	051394
2-Gang Thermoplastic Decorative Wall Plate   Jumbo Size	32	Matte Black	051404
2-Gang Thermoplastic Blank Wall Plate   Mid-Size	32	Matte Black	051444
1-Gang Thermoplastic Blank Wall Plate   Mid-Size	32	Matte Black	051454
4-Gang Thermoplastic Decorative Screw-less Wall Plate   Mid-Size	34	W, I, LA, B	051491-96
2-Gang Thermoplastic 1 Toggle Switch & 1 Duplex Receptacle Wall Plate   Mid-Size	33	Matte Black	051724
1-Gang Thermoplastic Duplex Receptacle Wall Plate   Jumbo Size	33	Matte Black	051734
2-Gang Thermoplastic Duplex Receptacle Wall Plate   Mid-Size	33	Matte Black	051744
4-Gang Thermoplastic Decorative Wall Plate   Standard Size	32	Matte Black	051754
2-Gang Thermoplastic 1 Toggle Switch & 1 Decorative Wall Plate   Mid-Size	33	Matte Black	051824
1-Gang Thermoplastic Blank Screw-less Wall Plate	34	W, I, LA, B	053941-46
2-Gang Stainless Steel Duplex Power Outlet   Standard Size	36	Steel	055521
2-Gang Stainless Steel Single Power Outlet   Standard Size	36	Steel	055672
2-Gang Stainless Steel Power Outlet & Receptacle Wall Plate   Standard Size	36	Steel	055818
15 Amp 2-Wire, Single-to-single Cube Outlet Adapter w/light switch	41	White	120039
15 Amp 2-Wire, Single-to Triple Polarized Swivel Outlet Adapter	41	White	120051
15 Amp 2-Wire, Single-to Triple Grounded Swivel Outlet Adapter	41	White	120052

<p><b>National Sales Director</b></p> <p>O: 904-404-8977 ext. 120  E: sales@aidacorp.com  Sales   Price List   Quotes   Orders</p>	<p><b>Regional Sales Manager</b></p> <p>O: 904-404-8977 ext. 105  E: sales@aidacorp.com  Sales   Price List   Quotes   Orders</p>	<p><b>Marketing &amp; Communications</b></p> <p>O: 904-404-8977 ext. 106  E: marketing@aidacorp.com  Events   Marketing   Design   PR</p>	<p><b>Office Manager</b></p> <p>O: 904-404-8977 Ext. 107  E: accounting@aidacorp.com  AP/AR   Statements   HR   Payroll</p>
--	---	---	---



The logo for Aida, featuring the word "Aida" in a bold, stylized, dark red font. The letter "A" is particularly large and has a unique shape. A registered trademark symbol (®) is located at the top right of the letter "a".

**Aida<sup>®</sup>**

Aida reserves the right to change specifications and products with out notice.

©2025 | 9855 MINING DRIVE, SUITE 202 | JACKSONVILLE, FL 32257 | TOLL FREE: (844) 808-4435 | [aidacorp.com](http://aidacorp.com) | Part #900004